

**Iran Winch Engineering Company** was established in 1974 with the aim of supplying equipment for oil, gas and petrochemical projects. Since 1995, with the approach of domestic production and creating national production in the field of industry, it has started to manufacture steel equipment and electrical parts of petrochemicals, oil & gas refineries as well as steel industry. In addition to supplying equipment to its parent company (Tehran Javan Co.), it was also participated in projects in the mentioned fields in phases 8, 6-7 and 5 of South Pars & Darkhoein, also had cooperation with foreign contractors such as Daelim, Toyo- GGC and Eni. It has also completed several projects with domestic contractors and employers, including Sazeh, Tehran Jonoob, Mapna, , Chegalesh, Dorriz , NIOEC , NISOC and etc.

**The factory of this company** is located in Mohammadshahr, Karaj, on a land with an area of 20,000 square meters and has two production workshops of 600 and 400 square meters, office space with an area of about 200 square meters, roofed warehouse with 100 square meters and open warehouse with 2000 square meters, including many equipment such as CNC punching machine, NC / BREAK press machine, cutting machine and all kinds of impact presses and other various equipment.

**The company** has a separate warehouse at the beginning of Saveh Road with an area of 1200 square meters and 400 meters of covered warehouse to support and maintain raw materials and equipment required for projects.

**Iran Winch company** successfully received ISO 9001: 2000 with the helps of its experienced and committed experts and personnel in 2011 and also ISO 9001: 2015 with ISO /TS 290001: 2010 approach in 2020, environmental management system and Professional health safety based on ISO 140001, ISO 450001 with HSE-MS approach in the field of manufacturing, supplying and working as a contractor in the fields of oil, gas and petrochemicals.

**The main activities and products of Iran Winch Company are as follows:**

- Production of cable trays and ladders in different sizes with all accessories with different materials
- (Carbon Steel- Pre Galvanized - Aluminum and Stainless Steel)
- Production of standing support bases, brackets and fittings - unistrut rails and clamps
- Manufacture and supply of electrical pipes with different standards and production of its accessories
- Manufacturing and supplying equipment for earthing materials systems, lightning protection with all accessories
- Construction of lighting Pole
- Construction of telecommunication towers
- Supply of lighting equipment
- Supply of all explosion-proof equipment (boxes, glands, switches and sockets, etc.)

**Attached is a brief description of the completed projects along with the catalog of our services.**



شرکت مهندسی ایران وینچ (مسئولیت محدود)

Cable tray and ladder are designed and manufactured to ensure ease during installation.

Products are in 2 and 3 meter length as standard and offered in tree type of section:

- Inside returned flange
- 90 deg inside flange
- Returned flange

The section and its matching fittings are available in standard mill

- Galvanized finish (BS2989)
- Hot dip galvanized after fabrication finish (BS 729)
- Stainless steel (316 ,316L , 304)
- Aluminum

Materials and finishes are also available to suit customer's requirements. Below are cable tray ordering guide.

## CABLE TRAY & LADDER

### FLANGE TYPE

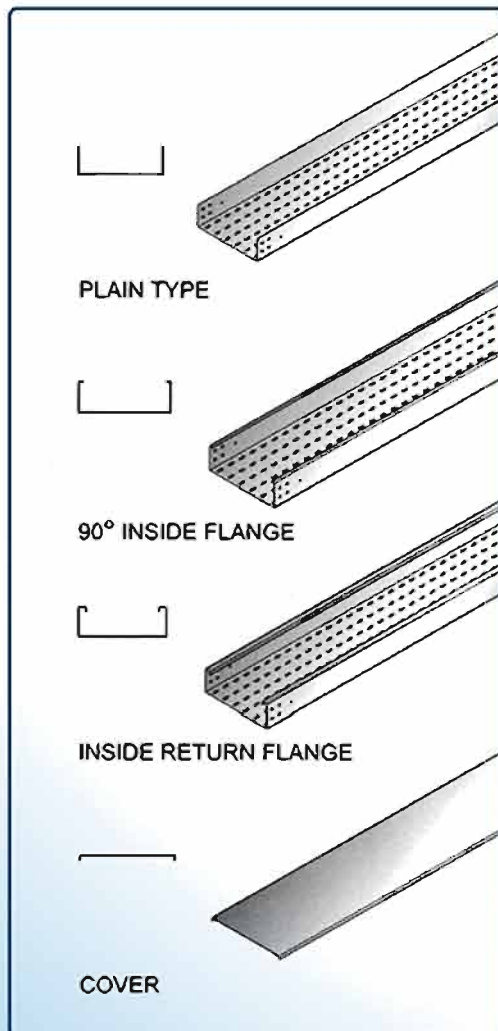

### FLANGE TYPE

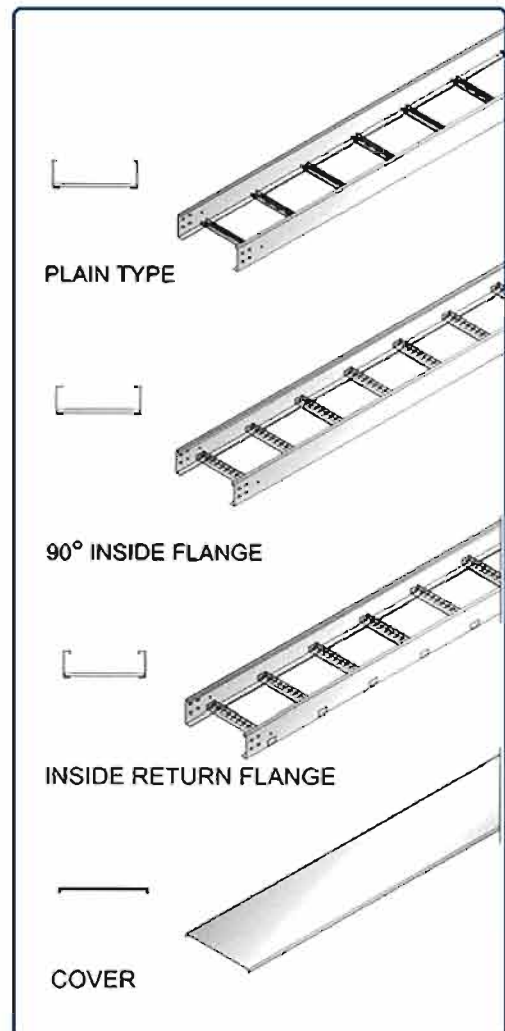

# SUPPORTS AND BRACKETS

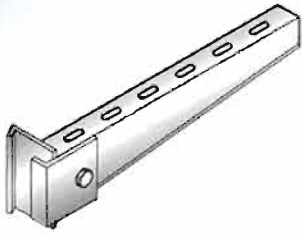

I BRACKET

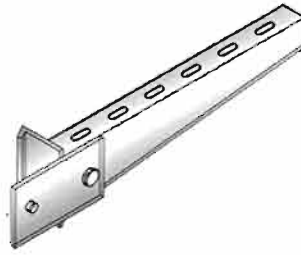

UNP BRACKET

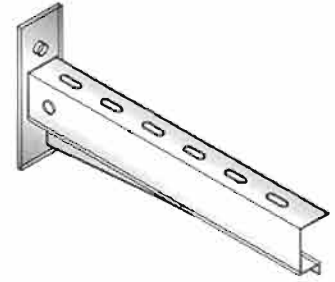

GENERAL BRACKET

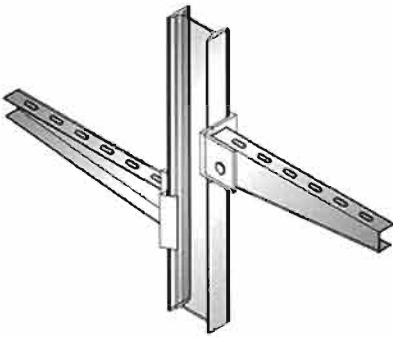

I SUPPORT

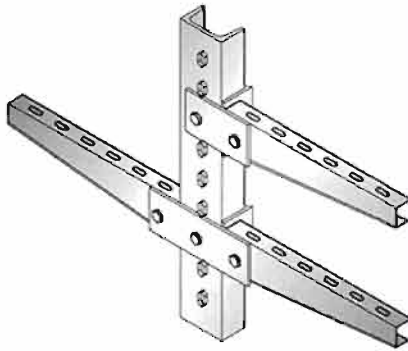

UNP SUPPORT

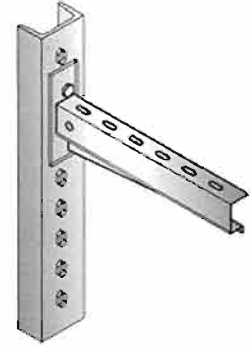

UNP SUPPORT

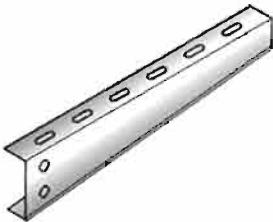

L BRACKET

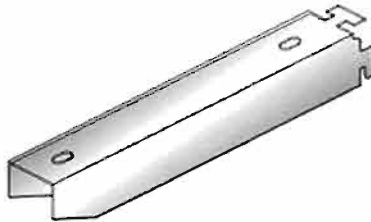

HOOKED BRACKET

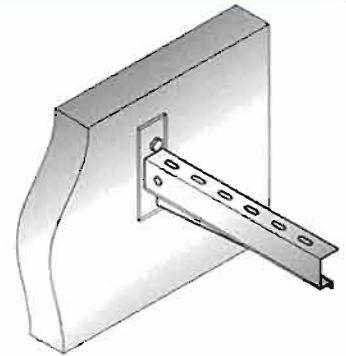

WALL BRACKET

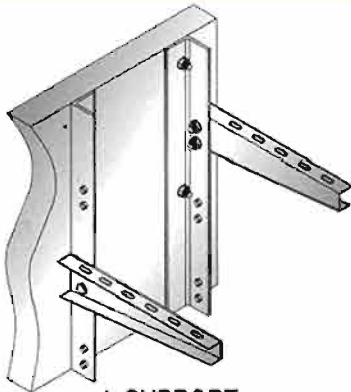

L SUPPORT

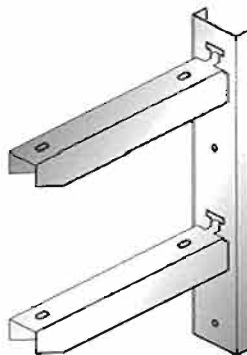

U SUPPORT

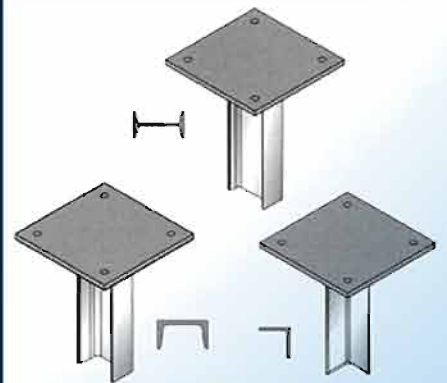

HEAD PLATE



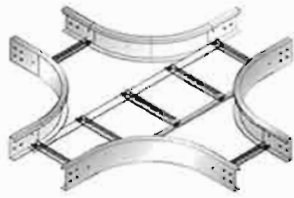

HORIZONTAL CROSS (R300)

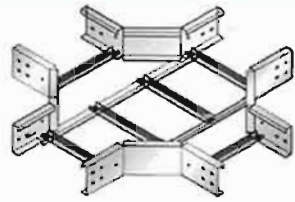

HORIZONTAL CROSS



90° INSIDE ADJ. VER. ELBOW



90° INSIDE VERTICAL ELBOW

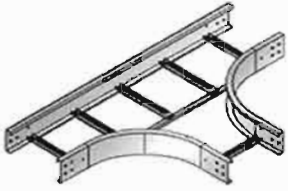

HORIZONTAL TEE (R300)

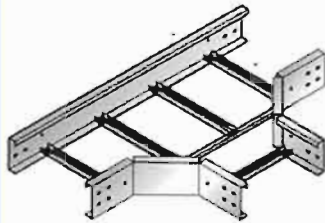

HORIZONTAL TEE

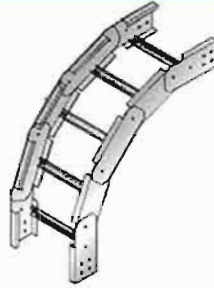

90° OUTSIDE ADJ. VER. ELBOW



90° OUTSIDE VERTICAL ELBOW



90° HOR. ELBOW (R300)

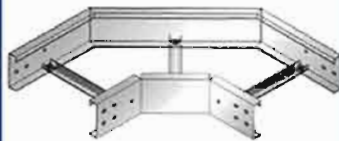

90° HORIZONTAL ELBOW

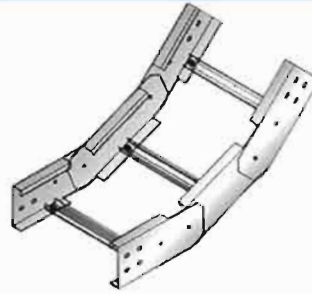

45° INSIDE ADJ. VER. ELBOW

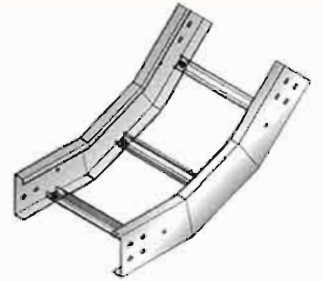

45° INSIDE VERTICAL ELBOW

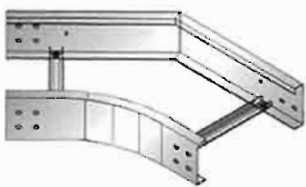

45° HOR. ELBOW (R300)

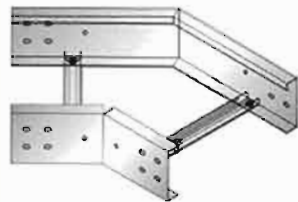

45° HORIZONTAL ELBOW



45° OUTSIDE ADJ. VER. ELBOW



45° OUTSIDE VER. ELBOW



30° HORI. ELBOW (R300)



30° HORIZONTAL ELBOW

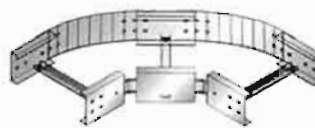

90° ADJ. HOR. ELBOW

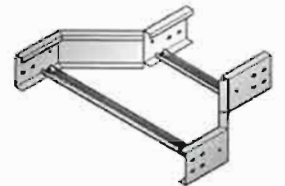

STRAIGHT REDUCER



JS  
STRAIGHT JOINTING PIECE



JV  
ADJ. VERTICAL JOINTING PIECE



PN  
END PLATE



JH  
ADJ. HORIZONTAL JOINTING PIECE



LEFTHAND REDUCER

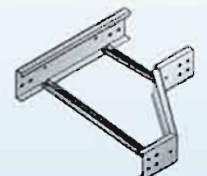

RIGHTHAND REDUCER

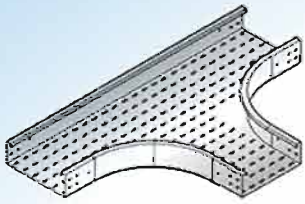

HORIZONTAL TEE (R300)

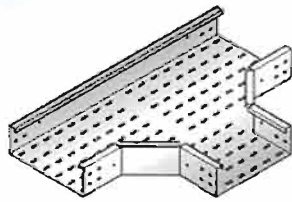

HORIZONTAL TEE

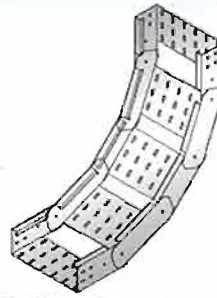

90° INSIDE ADJ. VER. ELBOW

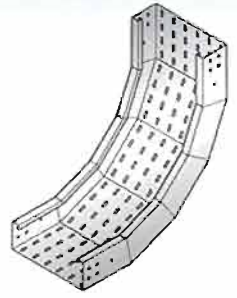

90° INSIDE VERTICAL ELBOW

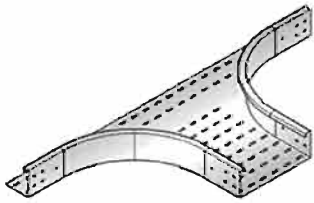

BRANCH TEE (R300)

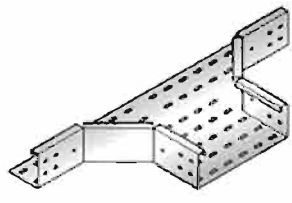

BRANCH TEE

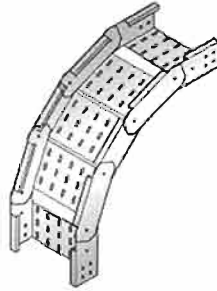

90° OUTSIDE ADJ. VER. ELBOW

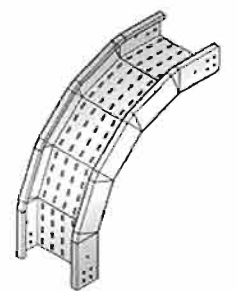

90° OUTSIDE VERTICAL ELBOW

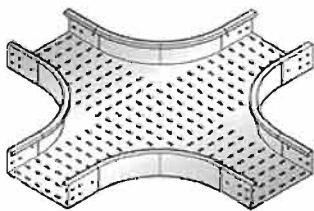

HORIZONTAL CROSS (R300)

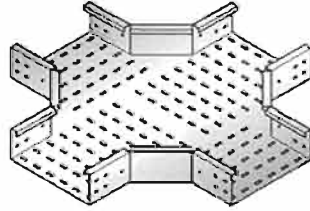

HORIZONTAL CROSS

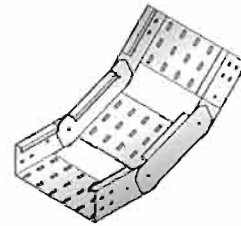

45° INSIDE ADJ. VER. ELBOW

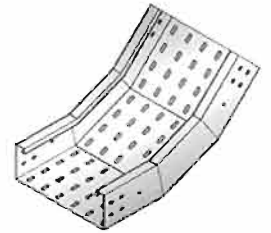

45° INSIDE VERTICAL ELBOW



90° HOR. ELBOW (R300)

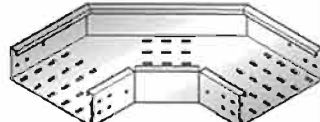

90° HOR.L ELBOW

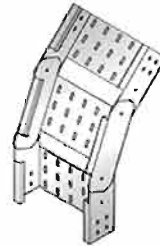

45° OUTSIDE ADJ. VER ELBOW

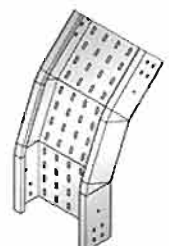

45° OUTSIDE VERTICAL ELBOW

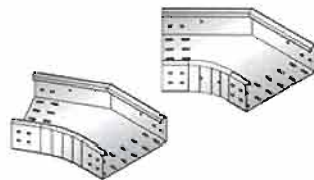

30°&45° HOR. ELBOW (R300)

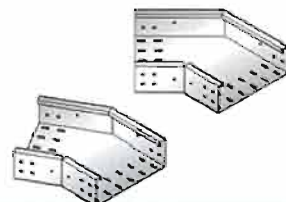

30°&45° HOR. ELBOW

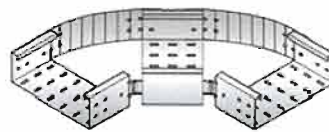

90° ADJ. HOR. ELBOW

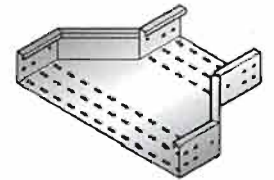

STRAIGHT REDUCER



STRAIGHT JOINTING PIECE



ADJ. VERTICAL JOINTING PIECE



'U' SHAPE JOINTING PIECE



END PLATE



ADJ. HORIZONTAL JOINTING PIECE



FISH PLATE

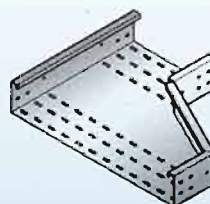

LEFTHAND REDUCER

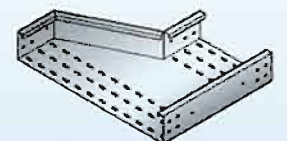

RIGHTHAND REDUCER



## ■ Rigid Steel Conduit & Accessories



Hot dip galvanized both in inner and outer walls to give a thigh protection to withstand any harsh environment. Threaded at both ends, complete with a coupler one end and protected with a plastic end cap on the other end. Supplied in standard length Of 3 meters and 3 meters.

- **Standard:**  
BS4568  
Pg – IEC981  
Din 2440

- **Accessories:**  
Coupling  
Bushing  
Elbow  
Tee  
Saddle  
Support



## Flexible Conduit & Connectors

Flexible conduit, Electrical conduit connector and conduit fittings, wiring accessories De-likon cable protection metal hoses, perfect all-round protection for cables and lines.

- Flexible Metallic Conduit
- Flexible Non-metallic Conduit
- Flexible Conduit Connectors & Fittings
- Corrugated Stainless Steel Hose



### Explosion Proof Bulk Material

- Junction Box
- Pull Box
- Terminal & Control Enclosure
- Switched Sockets



## ■ Cable Gland & Accesories

- Industrial type brass indoor and outdoor cable gland for use with Single Wire Armor (SWA) cable providing an environmental seal on the cable inner sheath and the cable outer sheath.

**Design Specification:** BS 6121:Part 1:1989, EN 50262:1999, IEC 62444

**Mechanical Classifications :** Impact = Level 8, retention = Class B (EN 50262) Class D (IEC 62444)

**Ingress Protection Rating:** IP66

**Cable Gland Material:** Brass, Electroless Nickel Plated Brass, Stainless Steel, Aluminum

**Accessories:** Adaptor/Reducer, Earth Tag, Locknut, Serrated Washer, Entry Thread Seal, Shroud



- Ex Cable Gland Tri-Star Triple Certified Flameproof (Type "d"), Increased Safety (Type "e") and Restricted Breathing (Type "nR") cable gland for use in Zone 1, Zone 2, Zone 21 and Zone 22 Explosive Atmospheres with Single Wire Armour (SWA) cable.

**Design Specification:** EN 50262, BS 6121: Part 1:1989, IEC 62444

**Mechanical Classifications:** Mechanical Classifications

**Ingress Protection Rating:** IP66 (Standard), IP67 & IP68 option available on request

**Cable Gland Material:** Brass, Electroless Nickel Plated Brass, Stainless Steel, Aluminium

**Accessories:** Adaptor/Reducer, Earth Tag, Locknut, Serrated Washer, Entry Thread Seal, Shroud

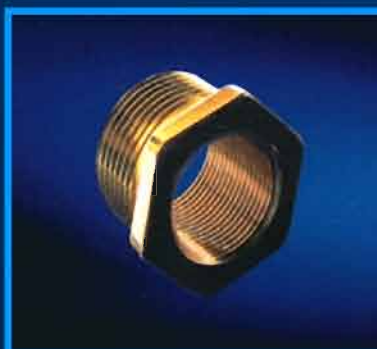



# Iran Winch Earthing Products

STD : BS - ANSI - IEEE



Earth Rods



Earth Clamps



Bonds and Clamp



Static Earthing Kits



Connectors



Earth Bus bars



Concrete inspection pit



Rod to tape clamp



Air rod base



Plate type test clamp



One hole cable clip



Rod to tape coupling



DC tape clip



Heavy duty cast cable saddle



Flat saddle



Square conductor clamp



Test clamp



Sing hole earth points



Earth point and bosses



Four hole earth points



Earth rods clamps



Air terminals



Earth rod



Flexible earth bonds



شرکت مهندسی ایران وینچ (مسئولیت محدود)

[www.iranwinch.com](http://www.iranwinch.com)  
[info@iranwinch.com](mailto:info@iranwinch.com)

## Summary of Iran Winch Works

<i>Client</i>	<i>Field of Work</i>	<i>Project</i>	<i>Date</i>
NIOEC	Conduit & Accessories	Refinery Turkmenistan	2000
SAZEH CO.	Conduit & Accessories	Bandar Imam Petrochemical Complex PTA 1	2000
NISOC	Plug Valve	Tapping Unit	2000
CHEGALESH	Conduit & Accessories	Bandar Imam Petrochemical Complex PTA 1	2001
NAMVARAN	Conduit & Accessories	Gol Gohar	2001
CHEGALESH	Conduit & Accessories	Tabriz Petrochemical	2001
CHEGALESH	Conduit & Accessories Earthing Matrials	Amir Kabir Petrochemical	2001
RASMARA INDUSTRIALGROUP	Conduit , Fitting & Cable Gland	South Pars , Phase 4.5	2002
HYUNDAI	Cable Tray , Ladder & Accessories	South Pars , Phase 4.5	2002
SAZEH ,TOYO	Flexible Conduit & Accessories	Aromatic 4	2002
CHEGALESH	Conduit , Cable Gland Earthing Matrials	Bandar Imam Petrochemical Complex PTA 2	2002
AJIP IRAN	Cable Tray , Ladder & Accessories	Darkhoien	2003
AJIP IRAN	Standing Support	Darkhoien	2003
NIGC	Cable Tray , Ladder & Accessories	Khangiran	2003
SADRA	Conduit & Accessories		2003
SAZEH	Ex Cable Gland & Accessories	Tabriz Petrochemical	2003
MESBAH ENERGY	Cable Tray , Ladder & Accessories		2004
JOINT VENTURE	South Pars , Phase 6.7.8	Cable Tray , Ladder & Accessories Earthing Material	2004
JOINT VENTURE	South Pars , Phase 6.7.8	Conduit , Fitting & Cable Gland	2004
SAZEH	Conduit & Accessories		2004
PARSOIL	Ex Cable Gland & Accessories		2005

# Summary of Iran Winch Works

<i>Client</i>	<i>Field of Work</i>	<i>Project</i>	<i>Date</i>
SAZEH	Conduit & Accessories	Arvand Petrochemical PVC	2006
EIED	Conduit & Accessories	Acetic Acid	2006
POGC / TIJD	Ex Cable Gland & Accessories	South Pars Phase 6.7.8	2007
NIGC	Conduit & Accessories Ex Junction Box	Khangiran Refinery	2007
EIED	Cable Tray , Ladder & Accessories Earthing Material	Ilam Petrochemical PVC	2007
			2008
ARPC	Cable Tray , Ladder & Accessories	Arak Refinery	2009
MAPNA BOILER	Conduit & Accessories Earthing Material	Tishreen Syria	2009
MIRAN NOOR	Cable Tray , Ladder & Accessories		2009
MAPNA BOILER	Conduit & Accessories		2009
MAPNA	Cable Gland & Accessories	FJ-147	2009
MAPNA	Reducer & Adaptor	DM-93	2009
BONIZ SAZEH	Conduit & Accessories		2010
NIGC	Ex Conduit & Accessories	Surface Treatment Water	2010
PIDCO	Cable Tray , Ladder & Accessories	NGL 900	2010
BALAGAR	Cable Tray , Ladder & Accessories	Iran LNG	2010
MAPNA	Earthing Material	South Pars , Phase 15.16	2010
SAFF	Earthing & Lightning System	South Pars , Phase 15.16 Oil Layer	2010
SAFF	Ex Material & Lighting Fixture	South Pars , Phase 15.16 Oil Layer	2010
EIED	Cable Tray , Ladder & Accessories Conduit & Accessories	Ilam Petrochemical	2010
OIEC	Earthing Material	NGL Siri	2010
ODCC	Conduit & Accessories	Sarvestan & Saadat Abad	2010



## Summary of Iran Winch Works

<i>Client</i>	<i>Field of Work</i>	<i>Project</i>	<i>Date</i>
KPC	Anthracite		2011
PETROAKSAN	Earthing Material	Homos Syria	2011
OIEC	Earthing & Lightning Material	NGL Siri	2011
PAREVAN GOSTAR	Conduit & Accessories		2011
NIGC	Flexible Conduit & Accessories	Surface Treatment Water	2011
NIGC	Ex Material , Socket/Plug	Surface Treatment Water	2011
SAFF	Lighting Material	South Pars , Phase 15.16 Oil Layer	2012
SHIRAZ SADID	Flexible Conduit & Accessories	Dalan Shiraz	2012
SHIRAZ SADID	Cable Tray , Ladder & Accessories	Dalan Shiraz	2012
EIED	Conduit & Accessories		2012
JOUNDI SHAPOR	Local Control Station	Shorijeh	2012
JAHANTAB	Cable Tray , Ladder & Accessories		2012
ARPC	Conduit & Accessories	Arak Refinery	2012
KPC	Anthracite		2012
NIGC	Motor Control Center	Khangiran Refinery	2012
NIGC	Flexible Conduit & Accessories	Khangiran Refinery	2012
SHIRAZ SADID	Ex Material & Cable Gland	Dalan Shiraz	2012
KPC	Cable Tray , Ladder & Accessories		2012
ARPC	Conduit & Accessories		2012
ARSHIN TARH	Conduit PVC		2012
NIGC	Aluminium Conduit & Accessories	Khangiran Refinery	2012
MPNA BOILER	Flexible Conduit & Accessories		2013

# Summary of Iran Winch Works

<i>Client</i>	<i>Field of Work</i>	<i>Project</i>	<i>Date</i>
ZAFARAN	Cable Tray , Ladder & Accessories	Bandar Abbas Petrochemical	2013
ZAFARAN	Conduit & Accessories	Bandar Abbas Petrochemical	2013
PETROELECTRIC	Conduit & Accessories		2013
CONTROL PO	Flexible Conduit & Accessories		2013
ARPC	Cable Tray , Ladder & Accessories	Mahshahr	2013
KPC	Anthracite		2013
CONTROL PO	PG Conduit		2013
CONTROL PO	Conduit & Accessories		2013
PETRO IRAN	Intelligent Pig		2014
ARPC	Cable Tray , Ladder & Accessories		2014
ARPC	Conduit & Accessories		2014
NIGC	Conduit & Accessories	Khangiran Refinery	2014
NIGC	Aluminium Cable Tray , Ladder & Accessories	Khangiran Refinery	2014
SINOPEK	Cable Tray , Ladder & Accessories	Yadavaran	2014
SINOPEK	Cable Gland & Accessories	Yadavaran	2014
TEHRAN JONOB	Earthing & Lightning System	Genaveh	2015
IBNE SINA PETROCHEMICAL	Conduit & Accessories	MALEIC ANHYDRIDE	2016
IBNE SINA PETROCHEMICAL	Cable Tray , Ladder & Accessories	MALEIC ANHYDRIDE	2016
BALAGAR	Conduit Fitting	Esfahan Refinery Project	2016
Dorriz	Conduit Fitting & Cable Tray , Ladder , Accessories	Esfahan Refinery Project	2016 -2017
IBNE SINA PETROCHEMICAL	Cable Tray , Ladder & Accessories	MALEIC ANHYDRIDE	2017
RASMARA INDUSTRIALGROUP	Earthing & Lightning System	Qeshm Power Plant	2018

# Summary of Iran Winch Works

<i>Client</i>	<i>Field of Work</i>	<i>Project</i>	<i>Date</i>
BALAGAR	Cable Tray , Ladder & Accessories	Esfahan Refinery Project	2018
NIGC	Aluminium Conduit & Accessories	Khangiran Refinery	2018
MOHKM KARAN Co.	Cable Tray , Ladder & Accessories	Bid Bolland I Gas Refinery	2018
CHEGALESH	Cable Tray , Ladder & Accessories	Esfahan Refinery Project	2019-2020
PARS HASSAS Co.	Cable Tray , Ladder & Accessories	Esfahan Refinery Project	2020
JAM PETROCHEMICAL	Cable Tray , Ladder & Accessories	Esfahan Refinery Project	2020
ARAK PETROCHEMICAL	Cable Tray , Ladder & Accessories	Arak Refinery	2020
IBNE SINA PETROCHEMICAL	Cable Tray , Ladder & Conduit	Mahshar	2020
CHEGALESH	Cable Tray , Ladder & Conduit	Esfahan Refinery Project	2021
FANAVAR BARGH GOLESTAN	Sunshade		2021
ARAK PETROCHEMICAL	Cable Tray & Accessories	Arak Refinery	2021
JAM PETROCHEMICAL	Cable Tray & Accessories	--	2021
NASB NIROO Co.	Cable Tray & Accessories	West Karun Power Generation	2021
NASB NIROO Co.	Cable Tray & Accessories	West Karun Power Generation	2022
NIROU GOSTAR INSTITUTE	Cable Tray & Accessories	Gurreh-Jask Crude Oil Pipeline Project (4-2)	2022
ABSUN ZOLAL Co.	Conduit & Accessories	NGL	2022
ABSUN ZOLAL Co.	Conduit & Accessories	Arak Refinery	2022
NASB NIROO Co.	Cable Tray & Accessories	West Karun Power Generation	2022
Sarir Sanat Co.	Cable Tray , Ladder & Accessories	Sarcheshmeh	2022
ODCC	Cable Tray , Accessories & Conduit Fitting	DISTILLATE HYDROTREATING PROJECT SHIRAZ OIL REFINERY	2022
ABSUN ZOLAL Co.	Conduit & Accessories	LNG	2022